

HL9/7

socket connector DN75 plastic/cast iron



socket connector DN75 for push-fit connections
between cast iron and plastic pipes



techn. drawing

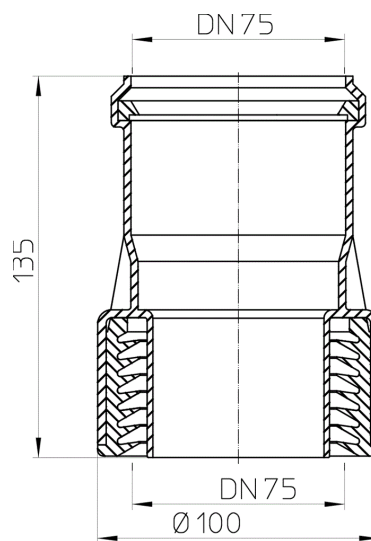

MAIN DATA

spare parts

 **HL01028D**
lip seal DN75

 **HL01063D**
lip seal DN75

Alternatives

 **HL9/7ET**
socket connector DN75 plastic/Eternit

TECHNICAL DATA

material	PP	installation height
dimension	DN75	grate frame
capacity		grate
weight	0,23	load class
EAN	9003076900978	inlet
		standards

PACKAGING DATA

carton

unit	10 [pcs.]
weight	2,62 [kg]
EAN/pack.	9003076004089
height/width/depth	210/330/330 [mm]
volume	0,022869 [m ³]

single use pallet

unit	600 [pcs.]
weight	177 [kg]
EAN/pack.	
height/width/depth	1800/800/1250 [mm]
volume	1,8 [m ³]

DOWNLOADS

Foto Print	HL9er_pr.tif	max.
Foto Web	HL9er_B.jpg	640x480/300dpi
Foto Symbol	HL9er_gr.jpg	150x150/72dpi
techn. drawing	HL9_7_a.pdf	pdf
CAD	HL9_7_2_a.dxf	dxf